

SCALE 1 : 6

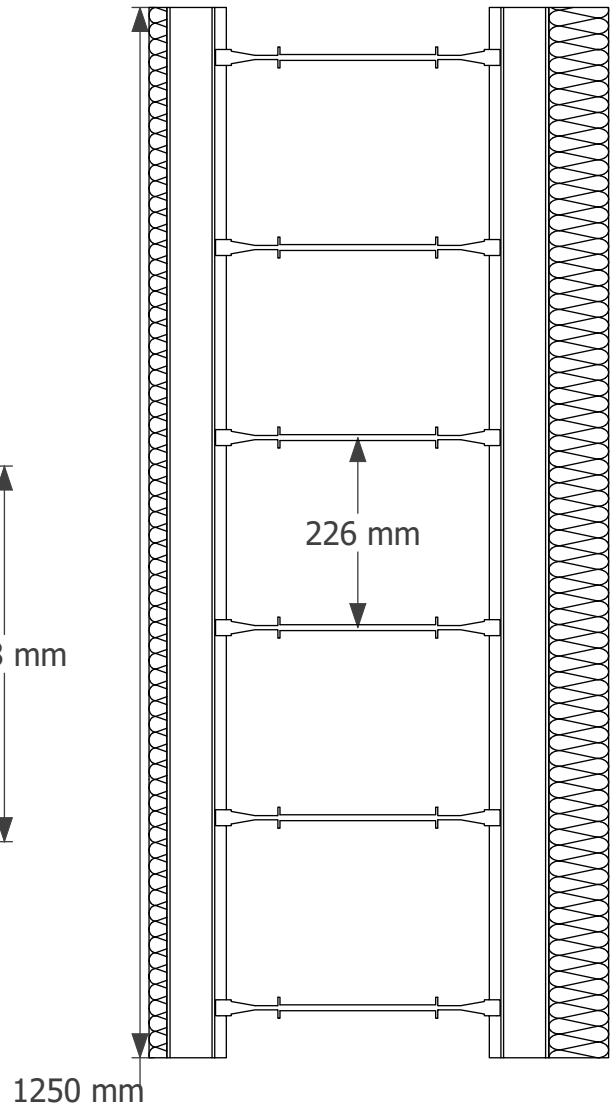

SCALE 1 : 9

This drawing is provided for the convenience of the designer.
 It is the designers responsibility to make necessary modifications to the drawing to ensure compliance with relevant building regulations and codes.
 R-WALL maintains the right to modify or make alterations to the drawing without notice.
 R-WALL will not be held liable in connection to, or use of this drawing, including, but not limited to, modifications, copying or distribution.



R-WALL[®]
 Insulating Concrete Formwork

**R-WALL 75mm 125mm
 12"(313mm) Wall Form**

| | |
|--------------------|-------------------------------|
| Scale: As Noted | DWG NO. PD75125313 |
| Rev NO: | Drawn By: J. Bowman |
| Rev Date: | |